

Design and Experimental Results of a Bench Top Flywheel-Accumulator for Compact Energy Storage

James D. Van de Ven
Jennifer A. McInnis

Worcester Polytechnic Institute
Department of Mechanical Engineering

ABSTRACT

The energy density of conventional hydraulic accumulators is significantly lower than competing energy domains. In this paper, a novel solution to improve the energy density of hydraulic energy storage, the flywheel-accumulator, is presented. The flywheel-accumulator integrates rotating kinetic and pneumatic energy storage, where the hydraulic fluid is used to change the mass moment of inertia of the flywheel. Furthermore, due to the two unique methods of adding energy to the system, the hydraulic system pressure becomes independent of the quantity of energy stored, enabling a constant system pressure. A computational model of the flywheel-accumulator is presented, which demonstrates an increase in energy density of 10 times greater than a conventional accumulator. The concept is demonstrated through the design and testing of a bench top prototype system. The bench top prototype includes a transparent chamber, allowing high-speed video visualization of the dynamic behavior.

INTRODUCTION / BACKGROUND

Reducing fossil fuel based energy consumption has become a global priority due to the cost, environmental, social, and political impacts. Many opportunities exist in fluid power systems to improve efficiency including improved component design, switch-mode (digital) control, improved system control strategies, and energy regeneration with storage. Energy storage is becoming an increasing popular option in applications from construction equipment, such as excavators, to hybrid vehicles.

When considering a hydraulic circuit with regenerative capabilities, such as the series hydraulic hybrid drive train illustrated in Figure 1, conventional hydraulic accumulators result in two major limitations. First, the energy density of advanced composite hydraulic accumulators approaches 6 kJ/kg^{-1} , which is two orders of magnitude lower than modern electric batteries²⁾. The limited energy density prevents scaling hydraulic hybrid drive trains to smaller vehicles with limited volume and prevents technologies such as “plug-in” hydraulic hybrids. Second, when an accumulator is connected to the high-pressure rail of a hydraulic circuit, the pressure

becomes a function of the quantity of energy stored. Thus for a 2:1 expansion ratio, the hydraulic components must be sized to provide the required power at half of the maximum operating pressure, resulting in heavy and bulky components.

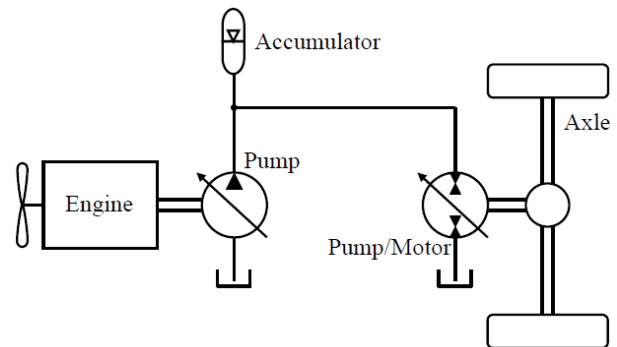

Figure 1. Series hydraulic hybrid drive train. Note that the pressure is determined by the accumulator state of charge.

A literature review of approaches to improve energy density of hydraulic accumulators was previously presented³⁾. These approaches successfully isothermalized the compression and expansion of the nitrogen gas through increasing the surface area with a variety of mediums⁴⁻⁷⁾. A less conventional approach is the open-accumulator, which combines both pneumatic and hydraulic energy storage with the benefits of a significant increase in energy density and the hydraulic pressure becoming independent of the quantity of energy stored⁸⁾. Another unconventional approach is a strain energy accumulator, where energy is stored by using hydraulic fluid to deform an elastomer⁹⁾. A final method, the topic of this paper creates multi-energy domain storage by integrating rotating kinetic and pneumatic energy storage in a flywheel-accumulator.

This paper presents the architecture and behavior of the flywheel-accumulator. First, the system is described through a basic steady-state analysis. Following the analytical analysis, the design of a low-energy bench top prototype is presented. Experimental methods, results, and a discussion follow. The paper closes with concluding remarks about future work for this promising technology.

FLYWHEEL-ACCUMULATOR

An alternative method to increase the energy storage density of hydraulic systems is to integrate pneumatic and rotational kinetic energy storage in a flywheel-accumulator. A piston style architecture of the flywheel-accumulator, as shown in Figure 2, is considered, however other architectures are also possible. The piston style flywheel-accumulator consists of a cylindrical pressure vessel with a piston separating compressed gas and hydraulic fluid with a hydraulic port at the center of the endcap. The flywheel accumulator rotates about the central axis and is coupled to a hydraulic pump/motor, either directly or through a gearbox.

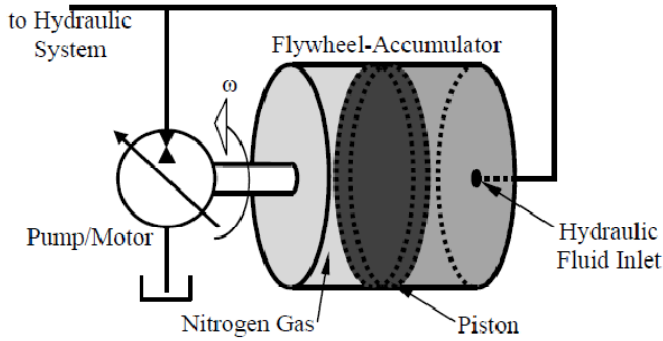

Figure 2. Piston-style flywheel-accumulator energy storage device.

As in a conventional accumulator, when hydraulic fluid enters the flywheel-accumulator, the piston moves axially and the gas is compressed. Because the density of nitrogen is low, the centrifugal force has little influence on the gas pressure distribution. However, the centrifugal force does create a significant radial pressure gradient in the hydraulic fluid, due to the higher density. From a force-balance on a fluid element subject to centripetal acceleration, the pressure of the fluid as a function of the radius is ³⁾:

$$P(r) = \frac{\rho\omega^2 r^2}{2} + P_s \quad (1)$$

where ρ is the mass density, ω is the angular velocity of the flywheel, r is the radius of interest, and P_s is the pressure at $r = 0$, which is equal to the pressure of the hydraulic system. This parabolic pressure gradient can be seen in Figure 3.

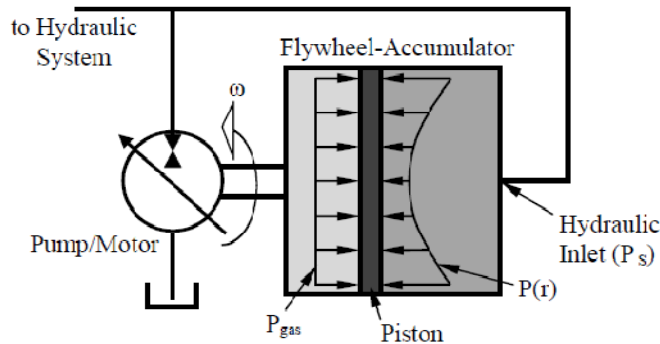

Figure 3. Diagram of the pressure distributions applied to the piston in the flywheel-accumulator.

To establish equilibrium, the axial forces acting on the piston due to the gas and hydraulic pressure must be equal. By integrating the two fluid pressures across the area of the piston and assuming isothermal gas behavior, the hydraulic system pressure is described by ³⁾:

$$P_s = P_{gas} - \frac{\rho\omega^2 r_o^2}{4} = P_{charge} \frac{l}{l-l_{oil}} - \frac{\rho\omega^2 r_o^2}{4} \quad (2)$$

where P_{gas} is the pressure of the nitrogen gas, assumed to be constant with radius, r_o is the outer radius of the piston, P_{charge} is the initial precharge pressure of the nitrogen gas, and l and l_{oil} are the length of the fluid areas of the accumulator and oil in the accumulator respectively.

When hydraulic fluid is added to the flywheel-accumulator, the mass moment of inertia increases. Assuming the density of the hydraulic fluid is constant with radius, which is reasonable for a high bulk modulus fluid, the mass moment of inertia of the flywheel-accumulator is described by:

$$I = I_{flywheel} + I_{oil} = I_{flywheel} + \frac{\rho V_{oil} r_o^2}{2} \quad (3)$$

where $I_{flywheel}$ is the inertia of the empty flywheel, I_{oil} is the inertia of the hydraulic fluid, and V_{oil} is the volume of oil in the accumulator.

Energy can be added or removed from the flywheel-accumulator in two ways, either through an applied torque or by adding or removing hydraulic fluid. When hydraulic fluid is added to the device, the piston compresses the gas, increasing the pneumatic energy storage, and the moment of inertia increases. In the absence of an applied torque, the increase in inertia creates a decrease in the angular velocity as described by the conservation of angular momentum. Both the increase in gas pressure and decrease in angular velocity result in an increase in the hydraulic system pressure. The basic form of Newton's second law for rotational systems describes the result of adding energy to device with an applied torque, T :

$$T = \frac{d(I\omega)}{dt} = \dot{I}\omega + I\dot{\omega} \quad (4)$$

If the quantity of hydraulic fluid in the flywheel-accumulator remains constant as a torque is applied, the angular velocity increases, causing a decrease in the hydraulic system pressure. This unique coupling allows the hydraulic system pressure to be directly controlled by modulating the method of energy storage.

To illustrate the behavior of the flywheel-accumulator, a simple example is provided using a first-order analysis that neglects dynamic behavior. Consider the case where energy is being stored in the flywheel-accumulator at constant power, such as descending a grade in a hydraulic hybrid vehicle. The flywheel-accumulator will start with a low state of charge, defined by low angular velocity and no hydraulic fluid in the

device. The energy will be stored in both rotating kinetic and pneumatic forms as controlled by a variable displacement pump/motor, with the goal of maintaining a desired pressure.

Numeric examples and details on the simulation method can be found in a previous work ³⁾, while the general trends will be discussed here. As seen in the top plot of Figure 4, the pressure starts at the precharge pressure of the accumulator. Because this precharge pressure is below the desired pressure, the hydraulic motor is set to zero displacement and all of the energy is stored by adding hydraulic fluid to the flywheel-accumulator. Adding hydraulic fluid results in an increase in the gas and hydraulic pressure and an increase in the mass moment of inertia. Because no torque is applied during this period, the angular velocity decreases inversely with the moment of inertia. Once the hydraulic pressure reaches the desired pressure, energy is stored both by adding hydraulic fluid to the flywheel-accumulator and by using the hydraulic motor to apply a torque to the device. By controlling the displacement of the motor, the hydraulic system pressure remains constant with increasing energy storage.

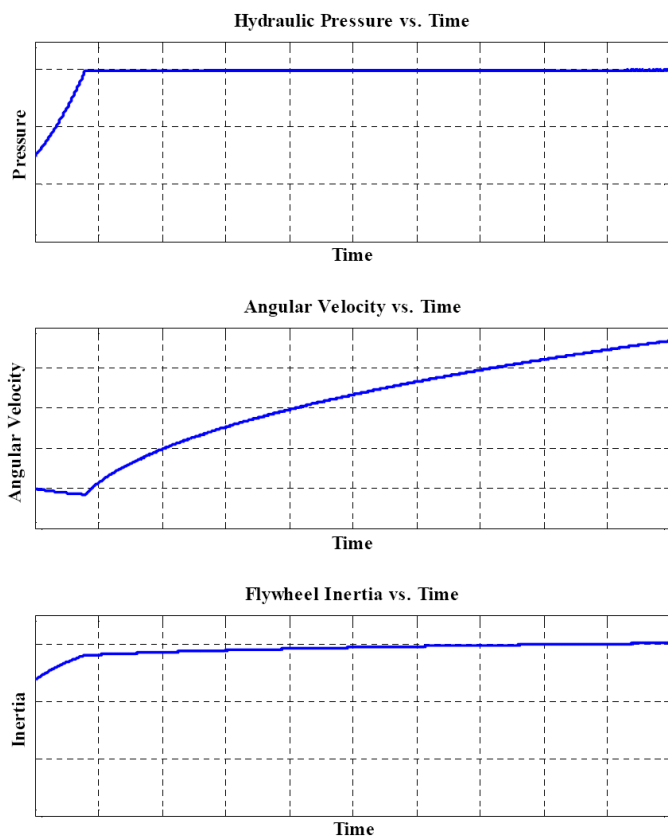

Figure 4. Pressure, angular velocity, and moment of inertia of the flywheel-accumulator during the energy storage simulation.

A few important observations can be made about the flywheel accumulator from this simple example:

1. **Energy Storage Capacity:** With reference to the top of Figure 4, the maximum capacity of a conventional accumulator is reached once the maximum pressure is reached. By also storing energy in rotating kinetic form, the flywheel-accumulator can store significantly more energy. By a conservative estimate, the flywheel-accumulator increases energy storage capacity by more than an order of magnitude ³⁾. This is an enabling element to numerous technologies. The limit of energy storage density is primarily a function of the allowable stress and deflection of the flywheel-accumulator shell.
2. **Constant Pressure:** With a conventional accumulator, the pressure significantly varies with the quantity of energy stored. This creates both control challenges and requires the hydraulic components to be oversized to meet the power demands at low system pressure. The flywheel-accumulator allows the hydraulic system pressure to be directly controlled independent of the quantity of energy stored.
3. **High Power Levels:** In the example, the power level was within the capability of the hydraulic motor. However, the hydraulic pump/motor does not need to be sized to meet high power transient events. During short-term high-power events, hydraulic fluid can be directly added or removed from the flywheel-accumulator, creating a change in the system pressure. Over a longer period, the pump/motor can reestablish the desired pressure. This allows the use of a smaller displacement pump/motor, which improves compactness while decreasing mass and cost.

PROTOTYPE DESIGN

To physically demonstrate and observe the behavior of the flywheel-accumulator, a bench top prototype was designed and constructed. The prototype was designed for low energy levels, eliminating the need for a vacuum chamber and allowing the pressure vessel to be made of a transparent material. The transparent cylinder allows observation of transient dynamic behavior and fluid flow using tracer additives and high-speed video. To study the contribution of the two energy domains separately, rotating kinetic energy is added and removed with an electric motor and hydraulic energy is separately controlled with a hydraulic power supply and a proportional valve. A diagram and photograph of the experimental system can be seen in Figure 5 and Figure 6 respectively.

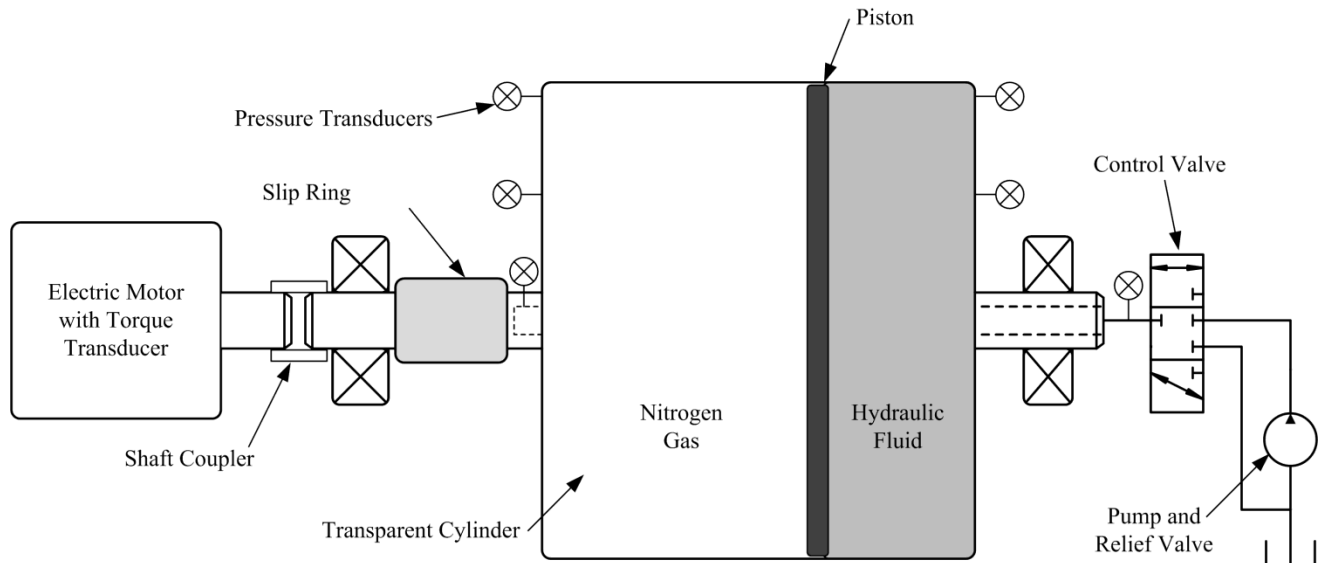

Figure 5. Diagram of the bench top experimental device. Energy is added or removed separately by the electric motor or the hydraulic circuit.

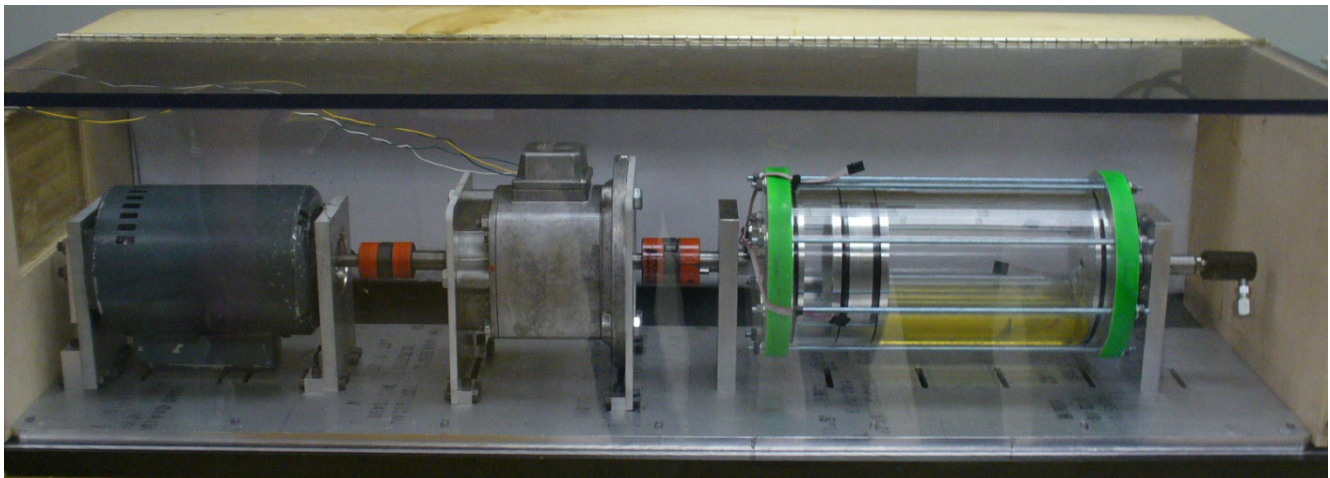

Figure 6. Photograph of the flywheel-accumulator bench top system. The components, left to right, are: electric motor, shaft coupler, clutch, shaft coupler, flywheel-accumulator, and hydraulic rotary union.

The flywheel-accumulator prototype is instrumented with numerous sensors. The pressure vessel contains three pressure transducers on the hydraulic fluid endcap that are spaced in the radial direction to measure the pressure gradient. The data from these rotating sensors is transmitted to ground through a precision slip ring. An optical gate that is tripped by a code wheel rotating with the flywheel is used for a tachometer signal. The torque of the hydraulic motor is measured using a load cell mounted between an arm on the motor and ground. Finally, the position of the piston is optically measured using a video camera and image processing. The data from the pressure transducers was amplified and all of the sensor data was acquired by a PC through a data acquisition board.

EXPERIMENTAL SETUP AND RESULTS

Preliminary experiments were run to validate the pressure predictions of the above analysis during steady-state operation. Initially, the gas chamber was

precharged with compressed air. Hydraulic fluid was then pumped into the stationary flywheel accumulator and the three pressure transducers were calibrated with an analog gauge at multiple pressures. After the piston position and angular velocity were set for an individual run, the system was operated at steady state for 30 seconds to eliminate any velocity gradients in the fluid. Pressure data was then collected at 100 samples per second for a five second period and averaged. The flywheel accumulator geometry and system parameters can be found in Table 1.

Table 1. Parameters of the experimental flywheel-accumulator system

Parameter	Symbol	Value	Units
Internal Diameter	r_o	6	cm
Accumulator Length	l	24	cm
Fluid Density	ρ	870	kg/m ³
Gas Precharge Pressure	P_{charge}	720	kPa
Radius to Pressure Transducer 1	r_1	0	cm
Radius to Pressure Transducer 2	r_2	2.3	cm
Radius to Pressure Transducer 3	r_3	4.6	cm

The pressure transducer calibrations were created with a least-squares best fit of the data to a linear relationship. The R^2 values of the fit to the equations range from 0.978 to 0.983. Plots of the measured and calculated pressure at the three locations on the hydraulic fluid side of the flywheel-accumulator for two conditions can be found in Figure 7 and Figure 8. Note that the calculated results utilize the value P_S from the experimental data as a small amount of the precharged gas leakage occurred, preventing Equation (2) from being used.

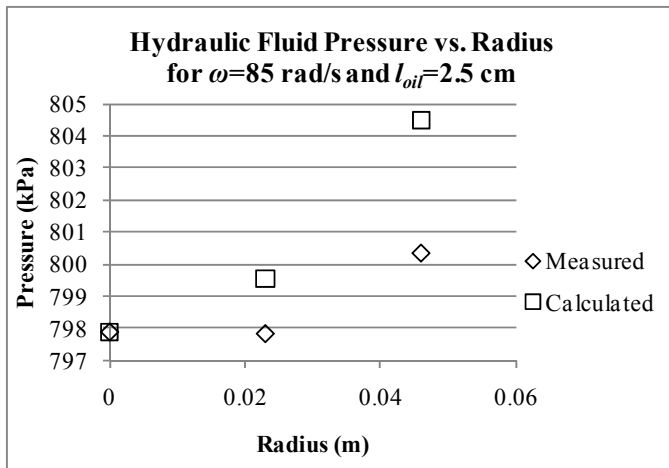

Figure 7: Experimental pressure measurement and calculated pressure in the hydraulic fluid as a function of radius for the conditions of $\omega = 85$ rad/s and piston position, $l_{oil} = 2.5$ cm

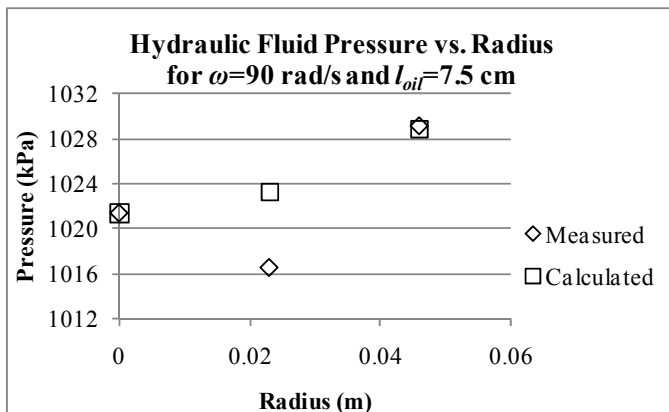

Figure 8: Experimental pressure measurement and calculated pressure in the hydraulic fluid as a function of radius for the conditions of $\omega = 90$ rad/s and piston position, $l_{oil} = 7.5$ cm

DISCUSSION

The two sets of experimental data shown above are compared to the calculated pressure values for the given angular velocity and radius and piston position. The data in Figure 10 matches the expected pressure gradient shape, however the pressure at the higher radii are lower than predicted. The data in Figure 11 show agreement with the pressure at the outer radius, yet an unexpected drop at the intermediate radius is observed. While these data sets are encouraging, more data and

system refinement is needed to validate the system behavior.

There are limitations to data collection that have not yet been overcome. Signal noise, while anticipated, continues to be a problem. Sources of signal noise include ambient influences such as fluorescent lights and AC power systems as well as the varying resistance of the slip ring during rotation. As predicted by Eqn. (1), at slow speeds, the pressure gradient is quite small and is likely within the noise of the sensors. Even at speeds up to 210 rad/s (1000 rpm) the pressure gradient of 17 kPa (2.5 psi) is near the range of the signal noise.

Multiple approaches can be taken to reduce the signal noise. First, additional shielding of the cables and junction boxes will be employed. If this is not sufficient, the instrumentational amplifiers will be placed at the pressure transducers on the flywheel-accumulator, eliminating the transmission of millivolt signal across the slip ring.

In addition to evaluating and reducing the effect of signal noise, it is necessary to collect data at higher speeds to analyze the system across the design range. The system was designed for a maximum speed of 314 rad/s (3000 rpm). However, data collection above approximately 100 rad/s is currently unreliable due to excessive vibrations created by the unbalanced flywheel. To operate at higher speeds, the flywheel-accumulator with the sensors needs to be dynamically balanced.

CONCLUSION

The energy storage density and pressure management potential of the flywheel-accumulator are promising. However, much further work is required, both in validation through the low-energy prototype and research and development for realization at full scale. Following improvements to the low-energy flywheel, a series of designed experiments will be conducted, both at steady-state and in transient conditions. During transients, fluid shearing will occur as the angular velocity of the flywheel-accumulator shell and the fluid differ. This shearing will result in both a decreased effective inertia and energy loss. The fluid swirl behavior in the open chamber and in the presence of telescoping baffles will be experimentally studied using high-speed video and tracer particles in the fluid.

In order to implement a high-energy flywheel accumulator in a fluid power system, multiple challenges need to be addressed. A few of these issues that will be addressed in the future research include:

1. Gyroscopic Torque: For operation in mobile applications, changing the pitch, yaw, or roll of the vehicle creates a gyroscopic torque. The gyroscopic torque can be minimized by rotating the flywheel about the vertical axis so changes in yaw do not result in an applied torque¹⁰. Alternatively, the gyroscopic torque can be eliminated by using two

counter rotating flywheels or by mounting a single flywheel in a gimbal.

2. Rotor Failure Modes: As with any form of energy storage, in the event of a failure, the flywheel-accumulator rotor can release energy in a dangerous manner. An area for future work when increasing the energy storage density is leveraging research in high-speed composite flywheel rotor design for energy dissipation during failure to minimize the energy absorption requirement of the vacuum chamber.
3. Seal and Bearing Design: Bearing and seal friction can be major sources to energy loss in high-speed flywheel systems¹¹⁾. The prototype described in this paper utilized conventional ball bearings and a rotary union. However, seal and bearing selection becomes more challenging for high-speed systems that require low friction.

In summary, the flywheel-accumulator has the potential to revolutionize fluid power energy storage by increasing the energy density by an order of magnitude and allowing control of the system pressure independent of the quantity of energy stored. Preliminary results from the low energy prototype are promising, but much future work is needed to further validate the concept and enable realization at high energy levels.

ACKNOWLEDGMENTS

The authors would like to thank the senior capstone design team consisting of Rahul Mahtani, Angel Martinez, Rachel Salvatori, and Robert Sayre for constructing the experimental prototype.

REFERENCES

- 1) Pourmovahed, A., "Sizing Energy Storage Units for Hydraulic Hybrid Vehicle Applications," American Society of Mechanical Engineers, Dynamic Systems and Control Division, Vol. 52, New Orleans, LA, 1993, pp 231-246.
- 2) Sclater, N., *Electronic Technology Handbook*, McGraw-Hill, New York, 1999.
- 3) Van de Ven, J. D., "Increasing Hydraulic Energy Storage Capacity: Flywheel-Accumulator," *International Journal of Fluid Power*, Vol. 10, No. 3, 2009, pp 41-50.
- 4) Otis, D. R., "Thermal Losses in Gas-Charged Hydraulic Accumulators," *Intersociety Energy Conversion Engineering Conference*, Philadelphia, PA, 1973, pp 198-201.
- 5) Pourmovahed, A., Baum, S. A., Fronczak, F. J., and Beachley, N. H., "Experimental Evaluation of Hydraulic Accumulator Efficiency with and without Elastomeric Foam," *Journal of Propulsion and Power*, Vol. 4, No. 2, 1988, pp 185-192.
- 6) Pourmovahed, A., and Otis, D. R., "An Experimental Thermal Time-Constant Correlation for Hydraulic Accumulators," *Journal of Dynamic Systems, Measurement and Control*, Vol. 112, No. 3, 1990, pp 116-121.
- 7) Sherman, M. P., and Karlekar, B. V., "Improving the Energy Storage Capacity of Hydraulic Accumulators," *Intersociety Energy Conversion Engineering Conference*, Philadelphia, PA, 1973, pp 202-207.
- 8) Li, P. Y., Van de Ven, J. D., and Sancken, C., "Open Accumulator Concept for Compact Fluid Power Energy Storage," *Proceedings of the ASME International Mechanical Engineering Congress*, Seattle, WA, 2007, pp 42580.
- 9) Pedchenko, A., and Barth, E. J., "Design and Validation of a High-Energy Density Elastic Accumulator Using Polyurethane," *ASME Dynamic Systems and Control Conference and Bath/ASME Symposium on Fluid Power & Motion Control*, 2009, pp.
- 10) Beachley, N. H., and Frank, A. A., "Flywheel Energy Management Systems for Improving the Fuel Economy of Motor Vehicles," *DOT/RSPA/DPB-50/79/1*, 1979, University of Wisconsin, Madison, WI.
- 11) Genta, G., *Kinetic Energy Storage; Theory and Practice of Advanced Flywheel Systems*, Butterworths, London, 1985.